

KWF210-24

24 Inch Farmhouse Workstation Single Bowl Stainless Steel Kitchen Sink

Kräus[®]

SPECIFICATION SHEET

Sink Dimensions

Overall Dimensions: 23 7/8" x 20 1/4"

Bowl Dimensions: 22" x 16"

Sink Depth: 10"

Features

- 16 Gauge Stainless Steel Construction
- Farmhouse Single Bowl Sink
- Required Minimum Cabinet Size: 27" Left to Right, 24" Front to Back
- Rear Off-Set Drain
- 3 1/2" Drain Opening
- NoiseDefend Undercoating and Sound Dampening Pads

Accessories Included

- Strainer ST-1
- Cover Cap STC-2
- Bottom Grid KBG-UN1-24
- Rolling Mat KRM-11BL
- Cutting Board KCB-WS101BB
- Cut-Out Template
- Mounting Hardware

CODES/STANDARDS:

Product Certification

cUPC (ASME A112.19.3/CSA B45.4)

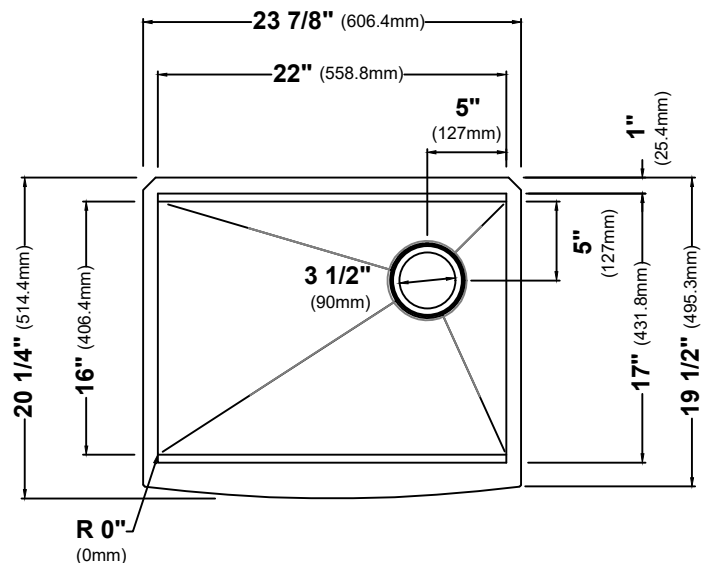

NOTE: It is not recommended to install this sink with a negative reveal. Doing so will prohibit the use of any workstation accessories as they will not fit.

Warranty

Kraus Limited Lifetime Warranty

see website for details www.kraususa.com

Kraus USA Customer Service

1.800.775.0703 | customerservice@kraususa.com

REV. January 26, 2021