

KRM-10

Multipurpose Roll-Up Dish Drying Rack

Rolling Mat Dimensions

Overall Dimensions: 20 1/2" x 12 3/4" x 3/8"

Features

- Roll-up over-the-sink drying rack
- Stainless steel construction with non-slip silicone coating
- Rolls up into a compact cylinder for storage
- Dishwasher safe
- Heat-safe up to 400° F
- Holds up to 85 lbs
- BPA-free and FDA-approved

Available Colors

- Black
- Grey
- Aqua
- Brown
- Dark Blue
- Dark Grey
- Green
- Red
- Yellow

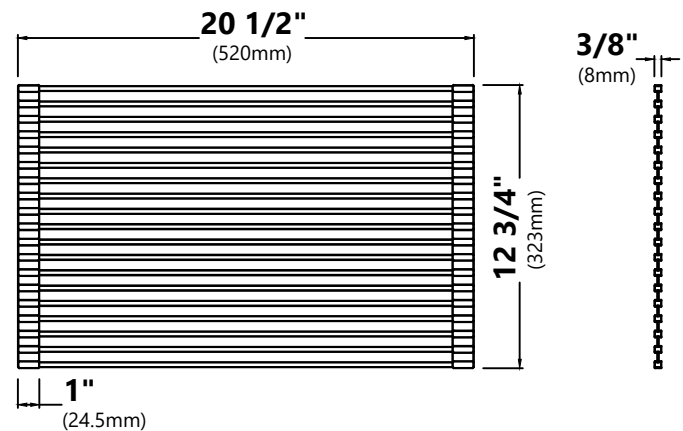

Warranty

Kraus One Year Limited Warranty
see website for details www.kraususa.com