

Kräus[®]

INSTALLATION MANUAL

Fireclay Dual Mount Workstation Kitchen Sink

KFDW1-33

Congratulations on the purchase of your new Kraus® plumbing fixture!

Please keep the box and packaging materials until your product is completely installed. If you have any questions, require technical assistance or have any problems with your product:

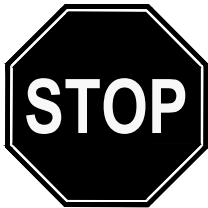

DO NOT RETURN TO STORE

**Please contact our Customer Service Team
1-800-775-0703 / customerservice@kraususa.com**

Have the model number available and retain a copy of your receipt with purchase date for reference.

If for any reason this product does not meet your expectations, please be sure to repack this product in the original box and packaging material to avoid damage during transit.



Prior to Installation:

- Make sure that you have all necessary parts by checking the parts list. If any part is missing or damaged, please contact Kraus Customer Service at 800-775-0703 for a replacement.
- Inspect the sink prior to installation to make sure that it has not been damaged during shipping.
- Read all instructions and safety warnings and ensure you have all tools, parts, and equipment necessary for a safe installation.
- Use the cut-out template provided by Kraus.
- Observe all plumbing and building codes according to your state requirements.
- To reduce the risk of personal injury, wear eye protection complying with ANSI standard Z87.1+ and cut resistant gloves complying with EN388 with non-slip grip when cutting or drilling, or when handling the sink and wear closed toe shoes at all times during installation.
- **Note:** Before installation, please check that the drain kit complies with ASME A112.18.2/CSA B125.2 and with CUPC certification.
- Additional floor and wall preparation may be required to avoid damaging the sink.
- Make sure to purchase the correct cabinet for your kitchen sink. Base cabinets should be 3" larger than the actual size of the sink.
- Not recommended to be installed with laminate countertop.

For technical assistance or replacement parts, please contact Kraus Customer Service and one of our representatives will be happy to help:













Toll-Free: 800-775-0703 or customerservice@kraususa.com

While these step-by-step instructions are intended to assist in the safe installation of a Kraus sink, this product is likely to perform best when installed by a licensed professional. The failure to follow these instructions or to hire a professional when needed may result in personal injury or property damage and may void the warranty.

Cleaning & Maintenance:

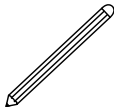
Clean your sink on a regular basis with warm soapy water. Rinse the sink after using cleaning products. Wipe the sink surface with a soft cloth to remove any liquid residue. Do not cut food directly on the surface of the sink. Do not leave sharp objects on the surface of the sink for an extended period of time. Do not use abrasive cleaning products, sanding tools, steel wool or bleaching products as use of such products may affect product performance or void the warranty.

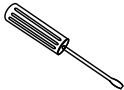
Tools you will need:

					
Safety Goggles	Drill	Silicone Adhesive	Jig Saw	Phillips Screwdriver	Cut Resistant Gloves
					
Putty Knife	Tape Measure	Pencil	Scissors	Screwdriver	Closed Toe Shoes

NOTE: Specialized tools may be necessary to install Kraus Fireclay sinks with countertop materials other than wood, marble or granite.

Dimensions

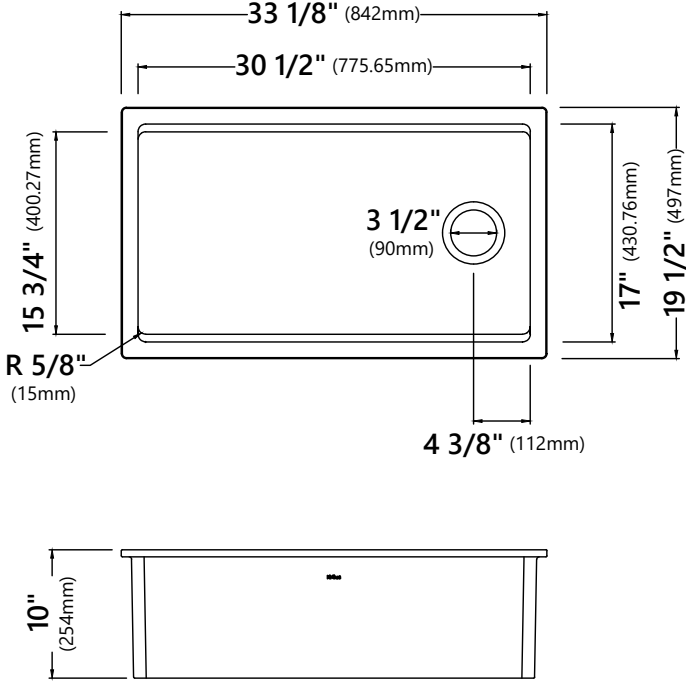

KFDW1-33
33 1/8" x 19 1/2" x 10"

Undermount Installation

1. Measure & Build Supports

- Build supports on inside of cabinet based on sink measurements

Installer Tip: Support options

- 1 1/4" Angle Irons
- (2) 2" x 4'
- 3/4" Plywood

NOTE: Due to the typical $\pm 3\text{mm}$ side wall variance in manufacturing, it is recommended that you design / modify the sink cabinet to match your clients individual sink(s) need.

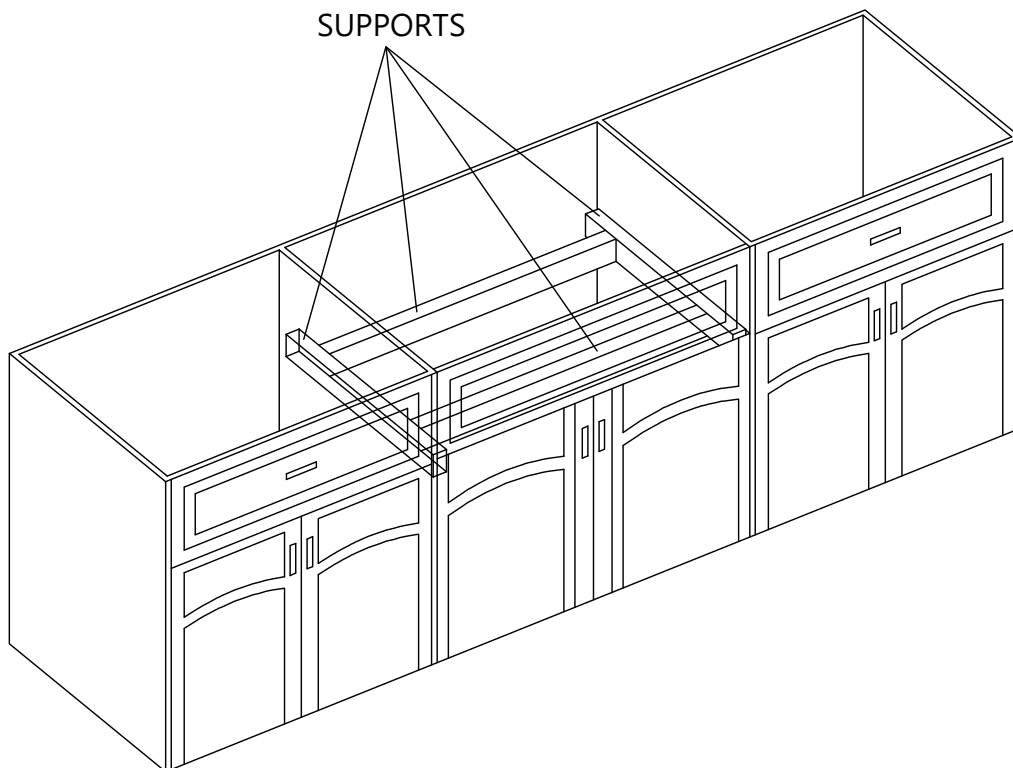

2. Install Sink

- Place sink in opening. The weight of sink should be sustained by the built supports.
- Make sure sink is leveled from front to back and side to side
- Make sure the top of the sink is flush with the top of the cabinet
- Uses silicone to fill in gaps where necessary

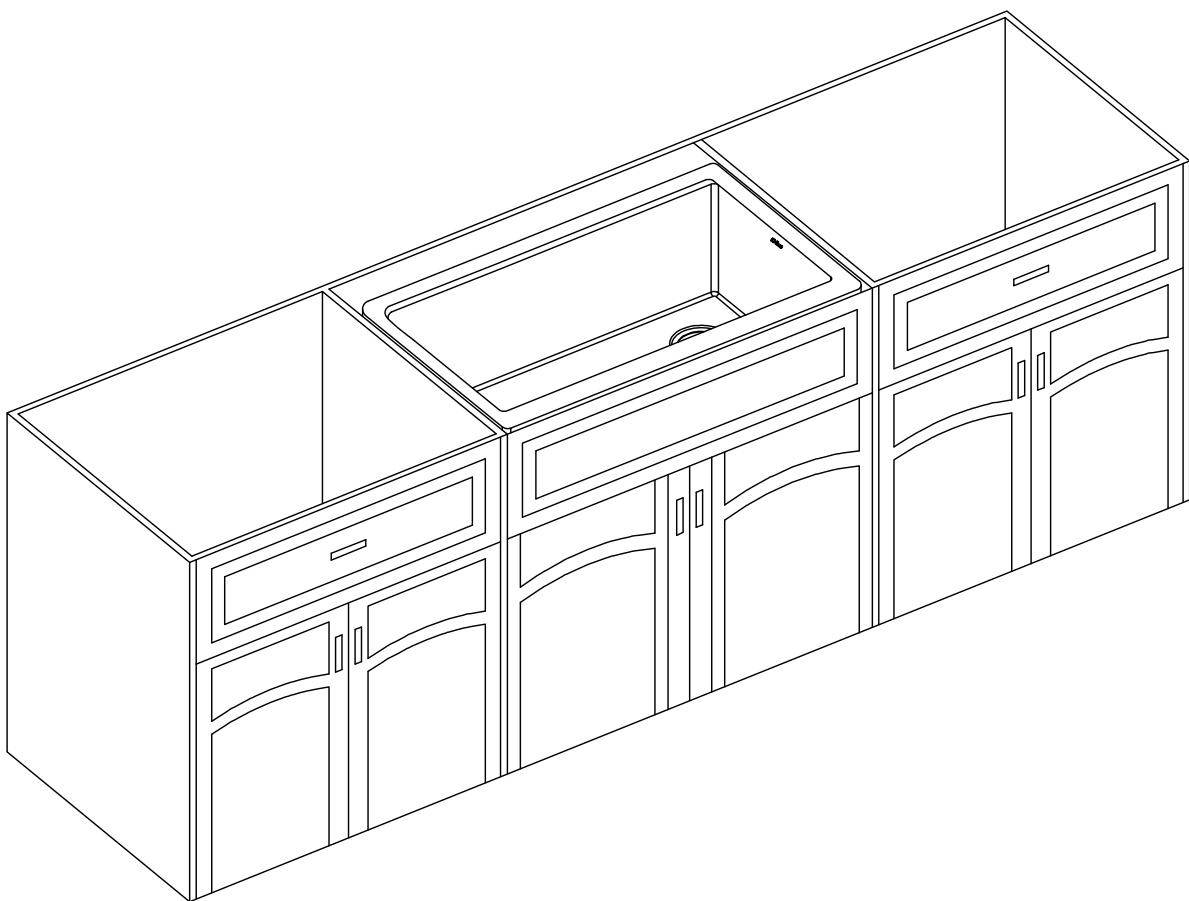

3. Cut Countertop

- Kraus recommends providing the cabinet maker with the actual sink to be installed prior to the cabinet fabrication.
- It is recommended that the sink be installed with an approximately 1/8" positive reveal. It is further recommended that the installer(s) discuss this with the customer and agree that this finished appearance is the desired effect.

⚠ CAUTION - To avoid the risk of personal injury, wear safety glasses and cut resistant gloves with non-slip grip when cutting.



NOTE: Please use the appropriate saw that best fits your countertop material.

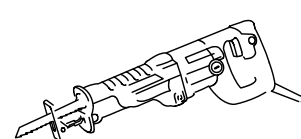
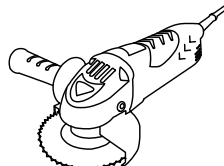
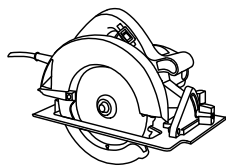
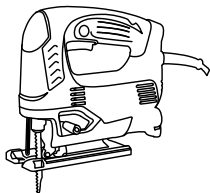
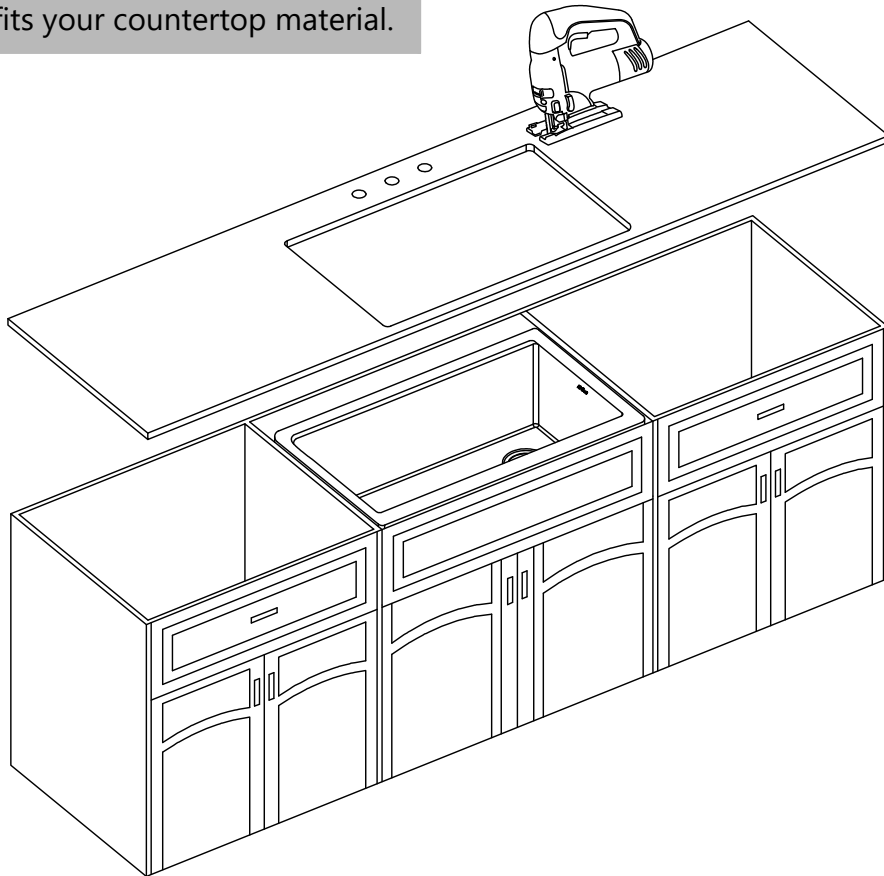

4. Install Countertop

- Use a bead of silicone (or preferred adhesive) around the rim of the sink. Check the alignment of the sink to the cutout in the countertop. Place countertop cutout hole over sink and press firmly.

Installer Tip: Use acetone or denatured alcohol to remove any excess sealant.

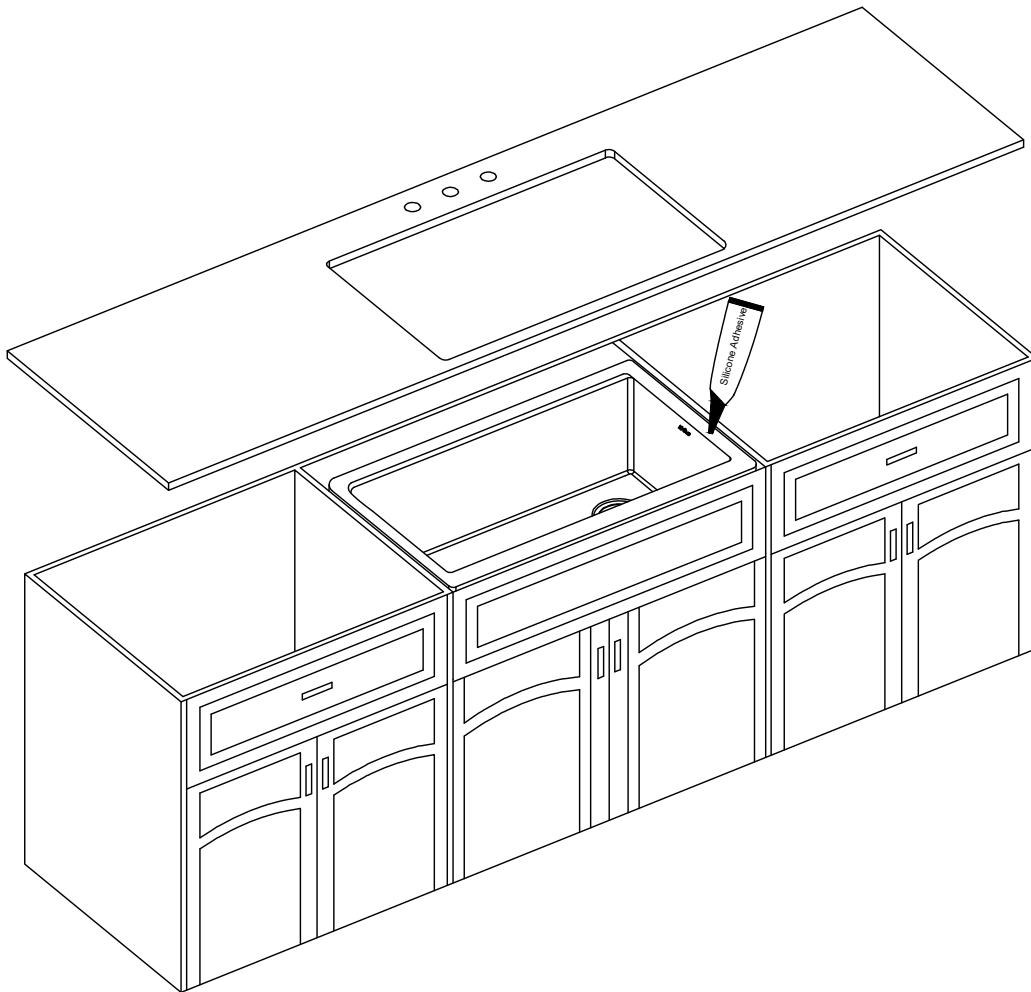

5. Installing Plumbing and Fixtures

- Connect drain, trap to drain and water supply connections to the faucet according to manufacturer's instruction.
- Run water into sink and check for leaks.

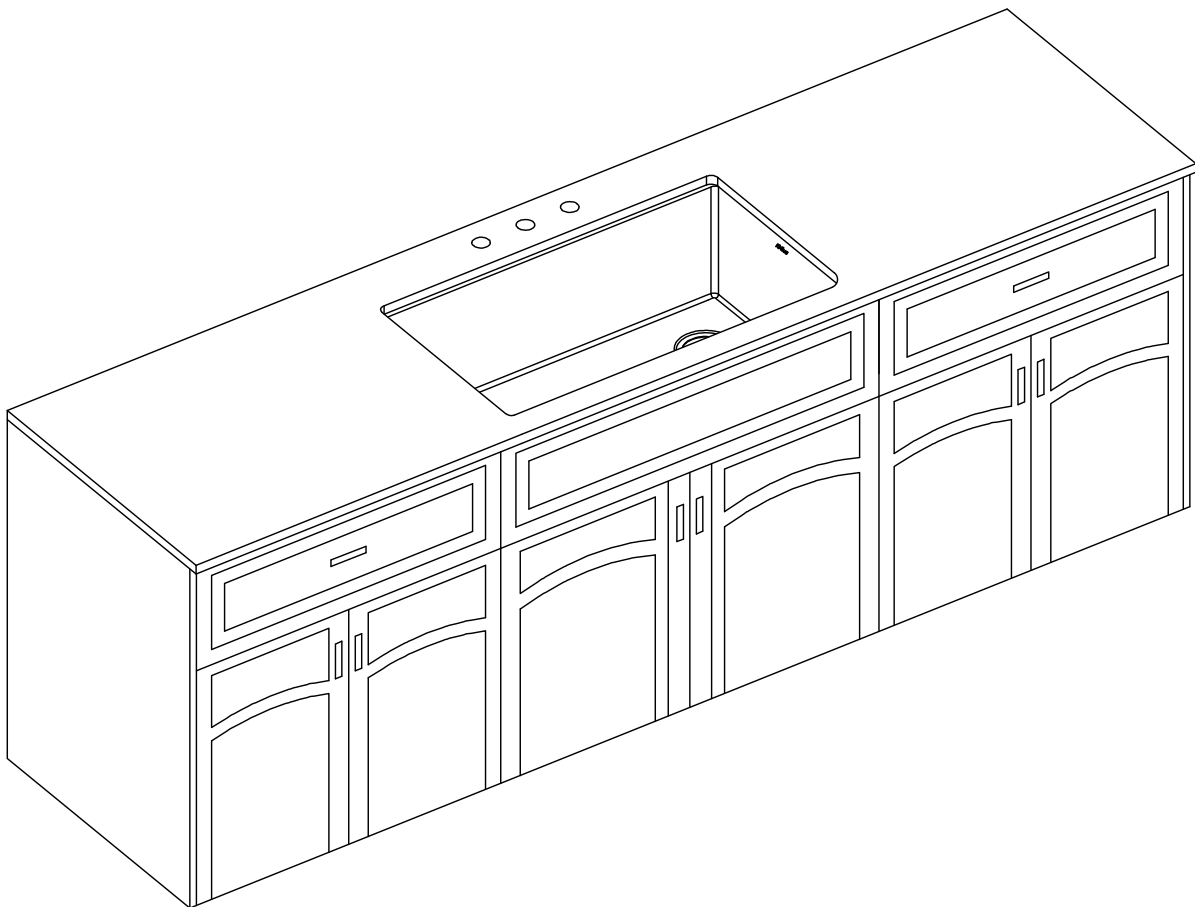

Top Mount Installation

1. Measure & Build Supports

- Build supports on inside of cabinet based on sink measurements
- The supports should be flush with the top of the cabinet

Installer Tip: Support options

- 1 1/4" Angle Irons
- (2) 2" x 4'
- 3/4" Plywood

NOTE: Due to the typical $\pm 3\text{mm}$ side wall variance in manufacturing, it is recommended that you design / modify the sink cabinet to match your clients individual sink(s) need.

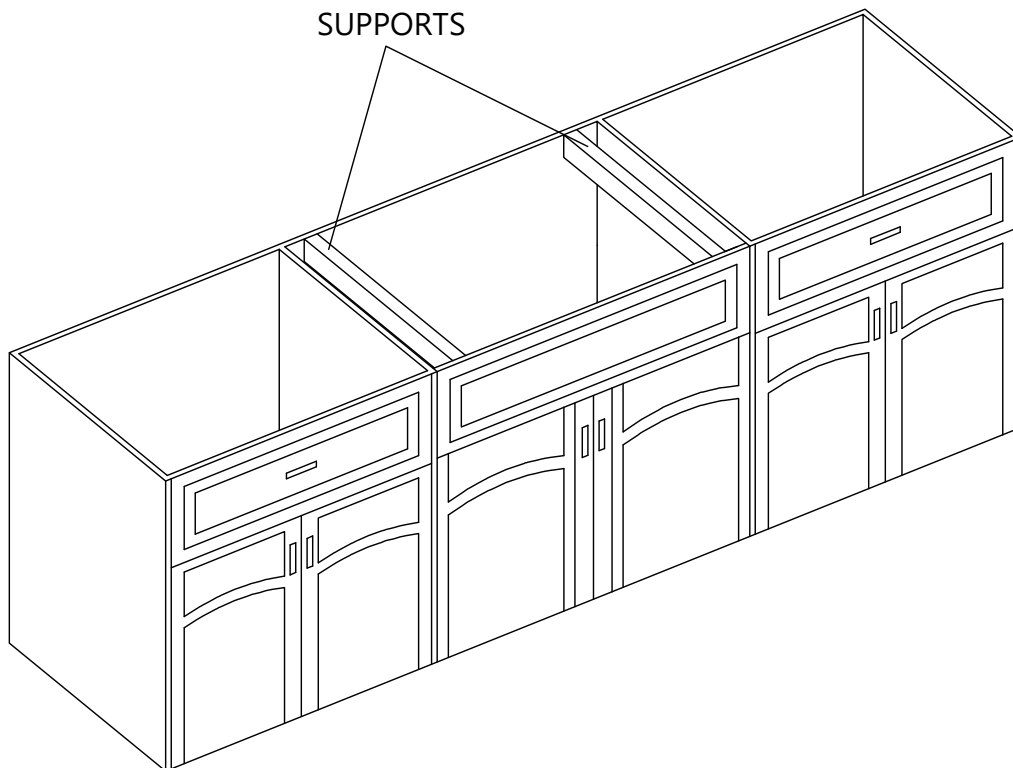

2. Measure Sink Opening

- Using the measurements of the sink, mark the countertop where it needs to be cut.

NOTE: Make sure clearance is suitable for backsplash, faucet and plumbing for the sink.

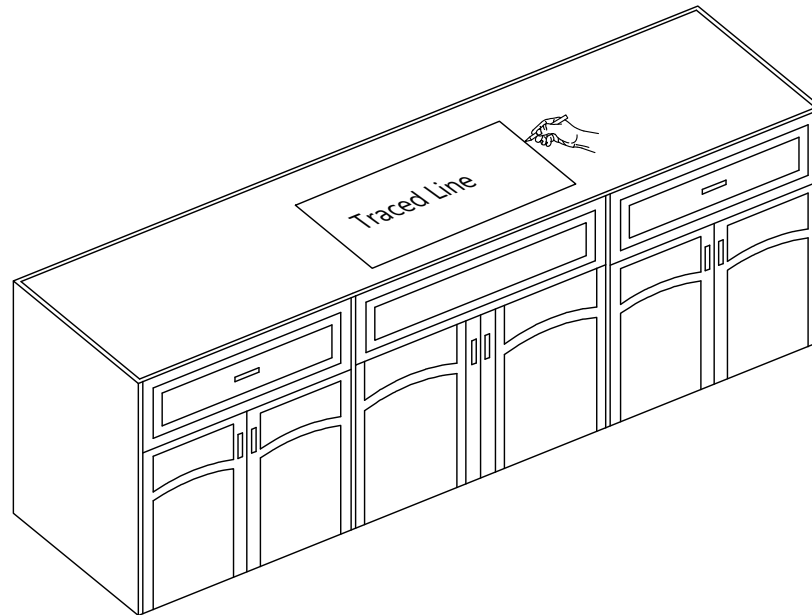

3. Cut Countertop

- Cut the opening in the countertop by carefully following the traced line.

⚠ CAUTION - To avoid the risk of personal injury, wear safety glasses and cut resistant gloves with non-slip grip when cutting.



NOTE: Please use the appropriate saw that best fits your countertop material.

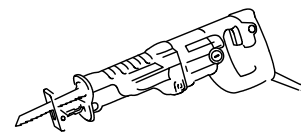
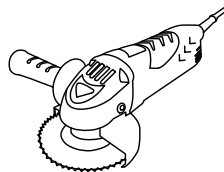
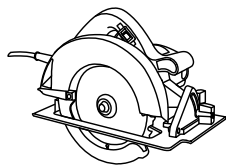
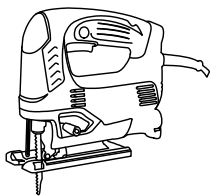
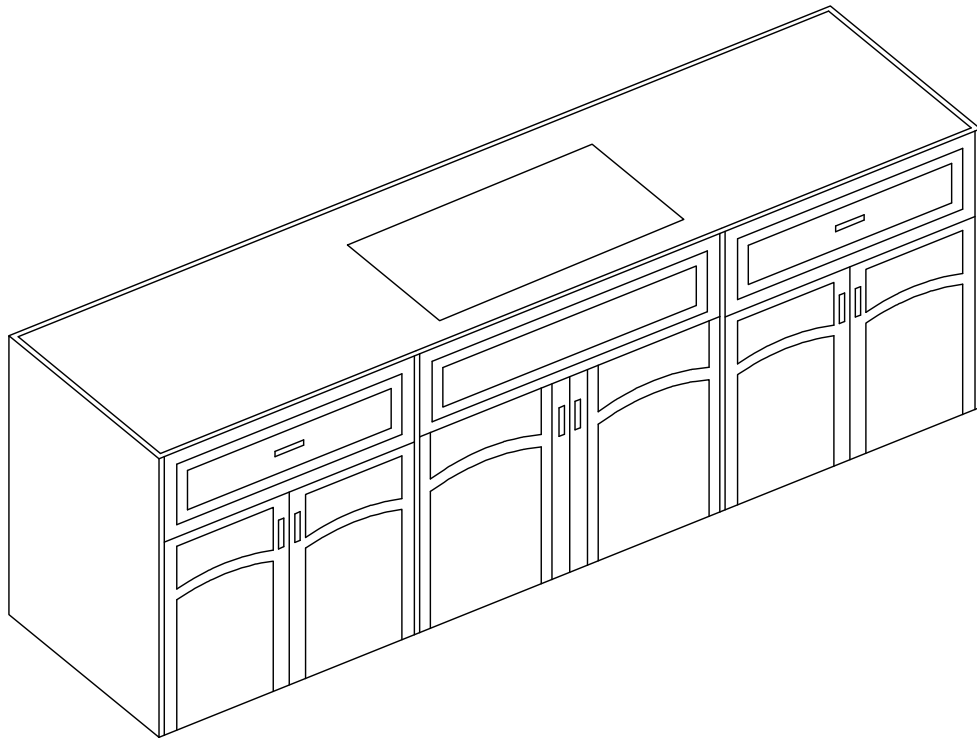

4. Apply Silicone or Plumber's Putty

- Clean and dry the surface around the opening of the sink.
- Turn the unit upside down to apply sealant. Apply silicone-based sealant (not included) underneath the edge of the sink.

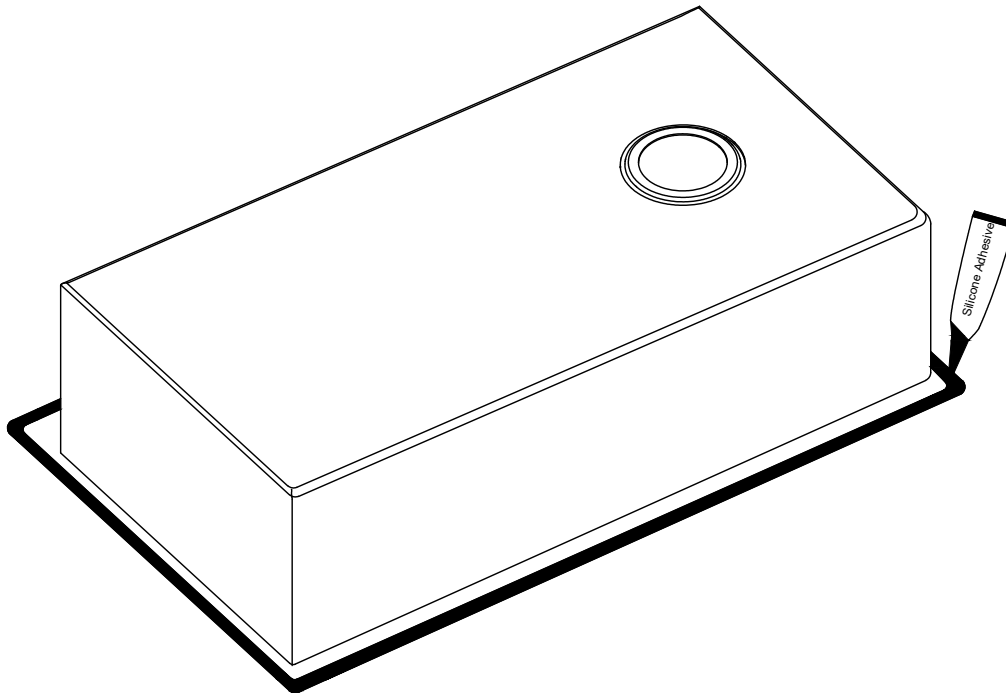

5. Secure Sink to Countertop

- Insert the sink into the opening, check the alignment of the sink to the cutout in the countertop and press firmly.
- Remove excess silicone-based sealant.
- Allow sealant to set for 30-60 minutes.

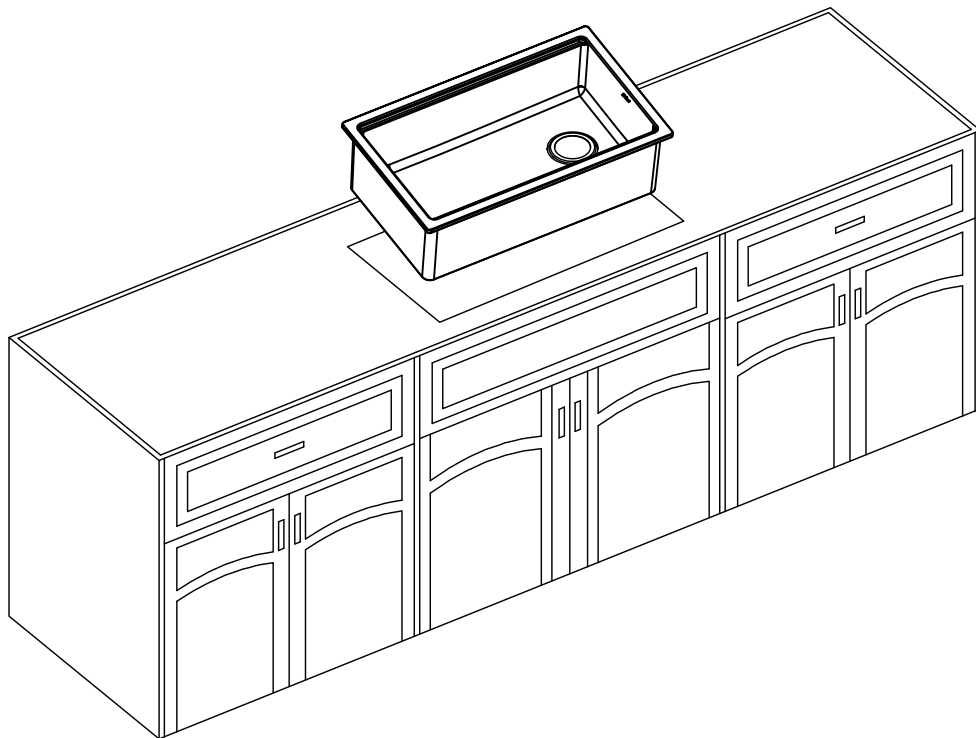

Codes/Standards Applicable:



Fireclay Kitchen Sink - Limited Warranty

Kraus® USA Plumbing, LLC ("Kraus") extends this warranty to the original purchaser for personal household use of the Fireclay Kitchen Sink when purchased from a Kraus authorized dealer and in the location of original installation. This warranty is non-transferable.

Kraus warrants the structure and finish of the Fireclay Kitchen Sink to be free from defects in material and workmanship under normal usage for a period of five (5) years from the date that the product is received by the original purchaser or their authorized representative (installation contractor, etc.).

Commercial Warranty

Kraus USA Plumbing, LLC ("Kraus") warrants its Products for a period of one (1) year to commercial purchasers of Products used in industrial, commercial and business applications.

What We Will Do

Any product reported to the authorized dealer or to Kraus that proves defective within the warranty period stated above will be repaired or replaced with a product of equal value at the option of Kraus. If repair or replacement is not practical, Kraus may elect to refund the purchase price in exchange for the return of the product. **These are your exclusive remedies.**

Care and Cleaning Instructions

Certain cleaning products may cause damage to a Product's finish and use of the following cleaning products on the Product will void this warranty:

- Abrasive cleaners such as powders, bleach, ammonia, alcohol or chlorine
- Abrasive pads, steel wool or wire brushes

Limitations

What is Not Covered

This warranty does not cover Products that were discontinued when purchased or display Products, whether such Products were purchased at discount outlets, unauthorized dealers, and/or sold on clearance. This warranty does not cover any free gifts included with purchase.

This warranty does not cover damage resulting from neglect, misuse (including use for an unintended application), abuse, carelessness, accident, hard water or mineral deposits, exposure to corrosive materials, improper maintenance, alteration of the Product, or failure to follow care, cleaning or installation instructions enclosed with your Product, and outdoor use. Kraus recommends that all Kraus Products be installed by a fully licensed and insured trade professional with experience in the installation of bathroom and/or kitchen manufactured goods.

How to Make a Warranty Claim

In requesting warranty service, please be ready to provide:

1. Proof of purchase.
2. A description of the problem.

If you are a **CONSUMER PURCHASER**, please contact a Kraus[®] Customer Service Representative at:

Kraus USA Plumbing, LLC
12 Harbor Park Drive
Port Washington, NY 11050
Toll-free 1-800-775-0703
Customerservice@kraususa.com

If you are a **PLUMBING CONTRACTOR OR TRADE PROFESSIONAL**, please contact a Kraus Pro Representative at:

Kraus USA Plumbing, LLC
12 Harbor Park Drive
Port Washington, NY 11050
516-801-8955
Proservice@kraususa.com

If you are an **AUTHORIZED PARTNER**, please contact a Partner Support Representative at:

Kraus USA Plumbing, LLC
12 Harbor Park Drive
Port Washington, NY 11050
516-801-8954
Partnersupport@kraususa.com

This warranty gives you specific legal rights, and you may also have other rights which vary from state/province to state/province.

Shipping charges will be covered for the first (1) year of the warranted replacement part or product (HI, AK, and Puerto Rico shipping charges may apply). International shipping fees are not included.

Limitation on Duration of Implied Warranties

Please note that some states/provinces (including Quebec) do not allow limitations on how long an implied warranty lasts, so the below limitations may not apply to you. TO THE MAXIMUM EXTENT PERMITTED BY APPLICABLE LAW, ANY IMPLIED WARRANTY, INCLUDING THE IMPLIED WARRANTIES OF MERCHANTABILITY AND OF FITNESS FOR A PARTICULAR PURPOSE, IS LIMITED TO THE STATUTORY PERIOD OR THE DURATION OF THIS WARRANTY, WHICHEVER IS SHORTER.

Limitation of Special, Incidental or Consequential Damages

Please note that some states/provinces (including Quebec) do not allow the exclusion or limitation of special, incidental or consequential damages, so the below limitations and exclusions may not apply to you. TO THE MAXIMUM EXTENT PERMITTED BY APPLICABLE LAW, THIS WARRANTY DOES NOT COVER, AND KRAUS USA PLUMBING, LLC SHALL NOT BE LIABLE FOR, ANY SPECIAL, INCIDENTAL OR CONSEQUENTIAL DAMAGES (INCLUDING LABOR CHARGES TO REPAIR, REPLACE, INSTALL OR REMOVE THIS PRODUCT), WHETHER ARISING OUT OF BREACH OF ANY EXPRESS OR IMPLIED WARRANTY, BREACH OF CONTRACT, TORT, OR OTHERWISE.

Download the Kraus Care & Maintenance Guide at:
<http://www.kraususa.com/maintenance>

IMPORTANT

Register Your Kraus® Product

Activate Your Warranty

Access Premium Customer Support

Get Product Information

REGISTER TODAY

<http://www.kraususa.com/registration>



Kräus®
www.kraususa.com